

VE416FS & VE416FSD



WARNING



- Failure to follow Instructions and warnings can result in serious injury.
- Before installing, operating, or servicing the VE416FS or VE416FSD Tool read this Manual and all warning labels on the tool.
- Always wear safety glasses and foot protection.

If you need additional copies of the manual or have any questions about the safe operation of this tool, contact Victaulic, P.O. Box 31, Easton, PA 18044-0031, 610-559-3300.

INDEX

Hazard Identification 1

Operator Safety Instructions. 2

 General 2

 Tool Set-Up 2

 Operating Tool 2

 Tool Maintenance 3

Introduction 3

 Power Requirements 3

 Extension Cord Requirements 4

Tool Nomenclature. 5

Receiving Tool 6

Tool Setup 6

Pre-Operation Adjustments 10

 Grooving Rolls 10

 Pipe Preparation 10

 Groovable Pipe Lengths. 11

 Roll Guard Adjustment. 13

 Pipe Stabilizer Adjustment. 14

 Groove Diameter Stop Adjustment 15

Grooving Operation 17

Roll Changing 20

 Roll Removal 4 - 16" 20

 Roll Installation 4 - 16" 21

 Roll Installation 2 - 3½" 22

 Copper Roll Installation 2 - 6" and 8" 23

Maintenance Procedures 23

 General 23

 Lubrication Monthly (VE416FSD Only) 24

 Hydraulic Systems 24

Parts Ordering Information. 26

Accessories 27

Troubleshooting 28

Tool Rating and Roll Selection 29

 Standard and "ES" Rolls 29

 Schedule 5S and 10S Stain. Steel Pipe 30

 Copper Tubing. 30

Dimensions 31

 Seamless and Welded Steel Pipe 31

 Drawn Copper Tubing 31

Roll Groove Specifications 32

 Steel Pipe and all Materials Grooved with Standard and "RX" Rolls 32

 Steel Pipe and all Materials Grooved with "ES" Rolls 33

 Drawn Copper Tubing w/Copper Rolls 34

READ THIS FIRST – HAZARD IDENTIFICATION

Definitions for identifying the various hazard levels shown on warning labels or to indicate proper safety procedures in this Manual are provided below.



This safety alert symbol indicates important safety messages on warning labels and in this manual. When you see this symbol be alert to the possibility of personal injury and carefully read and fully understand the message that follows.

DANGER

- The use of the word "DANGER" always signifies an immediate hazard with a likelihood of severe personal injury or death if instructions, including recommended precautions, are not followed.

WARNING

- The use of the word "WARNING" signifies the presence of hazards or unsafe practices which could result in severe personal injury if instructions, including recommended precautions, are not followed.

CAUTION

- The use of the word "CAUTION" signifies possible hazards or unsafe practices which could result in minor injury, product or property damage if instructions, including precautions, are not followed.

NOTICE

- The use of the word "NOTICE" signifies special instructions which are important but not related to hazards.

OPERATOR SAFETY INSTRUCTIONS

This tool is designed only for roll grooving pipe. To accomplish this function requires some dexterity and mechanical skills, as well as sound safety habits. Although this tool is manufactured for safe dependable operation, it is impossible to anticipate those combinations of circumstances which could result in an accident. The following instructions are recommended for safe operation of the tool. The operator is cautioned to always practice "Safety First" during each phase of use, including setup and maintenance of this unit.

GENERAL

- 1. Read and understand this Manual before operating or performing maintenance on this tool.** Become familiar with the tool's operations, applications and limitations. Be particularly aware of its specific hazards. Store this manual in a clean area and always at a readily available location. Additional copies at no charge are available upon request by writing or phoning the Victaulic Tool Company.
- 2. Use only recommended accessories.** Use of improper accessories may be hazardous. See Accessories on page 27.
- 3. This tool is designed ONLY for roll grooving of pipe sizes, materials and wall thicknesses outlined under Tool Rating and Roll Selection, pages 29 and 30.**

TOOL SET-UP

- 1. Ground the power drive or tool.** Be sure the power drive, used with the VE416FS or the VE416FSD drive motor, is connected to an internally grounded electrical system.
- 2. Avoid dangerous environments.** Don't use the tool in damp or wet locations. Don't use the tool on sloped or uneven ground or floor. Keep work area well illuminated. Allow sufficient space to operate tool and accessories properly and for others to pass safely.

- 3. Prevent back injury.** During tool set-up, one person cannot safely lift and handle the VE416FS tool head assembly because it weighs at least 150 lbs. Two people are needed to safely lift and handle the assembly. If a hoist is available, use it to lift the tool head assembly into position

OPERATING TOOL

- 1. Inspect the equipment.** Prior to starting the tool, check the movable parts for any obstructions. Be sure that guards and tool parts are properly installed and adjusted.
- 2. Prevent accidental startings.** Place switch on the attached power drive (VE416FS only) in the "OFF" position prior to plugging in unit.
- 3. Operate with foot switch only.** The power drive (VE416FS only) must be operated with a safety foot switch as the operator will require it to operate the tool safely. If your power drive does not have a foot switch, contact power drive manufacturer. The VE416FSD comes equipped with a safety foot switch.
- 4. Keep hands away from grooving rolls and stabilizer wheel during grooving operation.** Grooving rolls can crush or cut fingers and hands.
- 5. Never reach inside pipe ends during operation.**
- 6. Do not over-reach.** Keep your proper footing and balance at all times. Be sure you can reach foot switch safely at all times. Do not reach across tool or pipe. Keep hands and loose tools away from moving parts.
- 7. Wear safety glasses and footwear.**
- 8. Keep work area clean.** Cluttered areas, benches and slippery floors invite accidents.
- 9. Wear ear protection if exposed to long periods of very noisy shop operations.**
- 10. Keep visitors away.** All visitors should be kept a safe distance from the work area.
- 11. Keep alert.** Do not operate tool if ill or drowsy from medication or fatigue. Avoid horseplay around tool and keep bystanders a safe distance from tool and pipe being grooved.

12. Do not operate tool at speeds exceeding those specified in this manual.

13. Wear proper apparel. Never wear loose clothing (unbuttoned jackets or loose sleeve cuffs) loose gloves or jewelry that can get caught in moving parts.

14. Do not force tool. It will do the job better and safer at the rate for which it was designed.

15. Support work. Support long pipe with a pipe stand secured to the floor or ground.

16. Do not misuse tool. Perform only the functions for which the tool is designed. Do not overload the tool.

TOOL MAINTENANCE

1. Unplug power cord prior to servicing.

Repair should be attempted only by authorized personnel. Always unplug power before servicing or making any adjustments.

2. Maintain tool in top condition. Keep tool clean for best and safest performance. Follow lubricating instructions.

INTRODUCTION

The Victaulic® Vic-Easy® Series 416 tool is available in two (2) different models. Both are designed to roll groove pipe of various materials and wall thicknesses to prepare it to receive Victaulic grooved pipe couplings (see Tool Rating and Roll Selection chart pages 29 and 30). Both are semi-automatic hydraulic feed tools intended for shop or field use.

The VE416FSD is a completely self contained unit with a gear motor, safety foot switch, and power cord/plug. The VE416FS requires a separate power drive. See Power Drive section, below.

CAUTION

- These tools should only be used for roll grooving pipe designated in the Tool Rating and Roll Selection chart on pages 29 and 30.

Use of the tools for other purposes or exceeding the pipe thickness maximums will overload the tools, shorten tool life and may cause tool damage.

Power Drive

The VE416FS tool is designed for power operation by mounting directly onto a Victaulic VPD752 or a Ridgid 300® power drive, (45 rpm maximum chuck speed). Consult drive manufacturer's instructions for proper operation

DANGER



- To reduce the risk of electric shock, check the electrical source for proper grounding and follow the instructions below.

- Before performing any repair or maintenance, disconnect the tool from the electrical source.

Failure to do so could result in death or serious personal injury.

POWER REQUIREMENTS

Power must be supplied through a safety foot switch to assure safe operation (standard on VE416FSD). Be sure the power drive is properly grounded in accordance with Article 250 of the National Electrical Code. If an extension cord is to be used, see Extension Cord Requirements chart on page 4 for cord size recommendations and always consult drive manufacturer's instructions prior to use.

EXTENSION CORD REQUIREMENTS

When pre-wired outlets are not available and an extension cord must be used, it is important to use the proper cord size (e.g., conductor size American Wire gauge). Cord size selection is based upon tool rating (amps) and cord length (feet). Use of a cord size (gauge) thinner than required will cause a significant voltage drop at the power drive or tool motor while the tool is operating. The voltage drop may cause damage to the power drive or tool motor and can result in failure of the tool to operate properly. Use of a heavier than necessary cord size (gauge) is acceptable.

Listed in the chart below are recommended cord size (gauge) for cord lengths up to and including 100 feet. Use of extension cords beyond 100 feet in length should be avoided.

Extension Cord Size (Gauge) Chart

Power Drive	Power Drive Rating Volt/Amps	Cord Lengths		
		25'	50'	100'
VPD752	115/15	12	12	10
Ridgid 300®	115/15	12	12	10
VE416FSD	115/15	12	12	10

® Registered trademark Ridge Tool Company

NOTICE

- Drawings and/or pictures in this manual may be exaggerated for clarity.

TOOL NOMENCLATURE

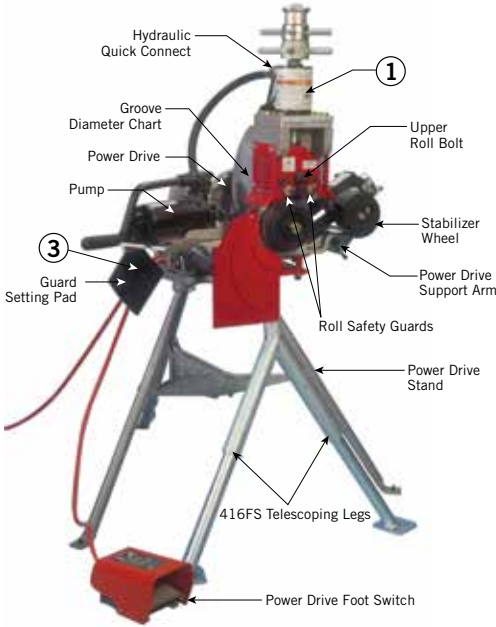

VE416FS

1

WARNING

Grooving rolls can crush or cut fingers and hands.

- Always turn off power before adjusting guard.
- Be sure guard is properly adjusted before grooving pipe.
- Keep hands away from grooving rolls and stabilizer wheel.
- Never reach inside pipe end or across the tool or pipe during operation.
- Never manually groove pipe shorter than what is recommended.
- Never wear loose clothing, loose gloves, or jewelry while operating tool.

416FS 1000416L00

WARNING

Failure to follow instructions and warnings can result in serious injury.

- Before installing, operating, or servicing this tool, read and understand the Operating Instructions and all warning labels on this tool.
- Always wear safety glasses and foot protection.

If you have any questions about the safe operation of this tool, contact Victaulic Tool Company, P.O. Box 31, Easton, PA 18044-0031, 610-859-3300. 0386 Rev. 0

3

ALWAYS KEEP THIS PAD WITH THE TOOL. USE IT TO SET THE GUARDS IN ACCORDANCE WITH THE TOOL OPERATION AND MAINTENANCE MANUAL.

1006272L08

2

WARNING

Grooving rolls can crush or cut fingers and hands.

- Always turn off power before adjusting guard.
- Be sure guard is properly adjusted before grooving pipe.
- Keep hands away from grooving rolls and stabilizer wheel.
- Never reach inside pipe end or across the tool or pipe during operation.
- Always groove pipe in a clockwise direction only.
- Never manually groove pipe shorter than what is recommended.
- Never wear loose clothing, loose gloves, or jewelry while operating tool.

416FS 1000416L00

WARNING

Failure to follow instructions and warnings can result in serious injury.

- Before installing, operating, or servicing this tool, read and understand the Operating Instructions and all warning labels on this tool.
- Always wear safety glasses and foot protection.

If you have any questions about the safe operation of this tool, contact Victaulic Tool Company, P.O. Box 31, Easton, PA 18044-0031, 610-859-3300. 0386 Rev. 0

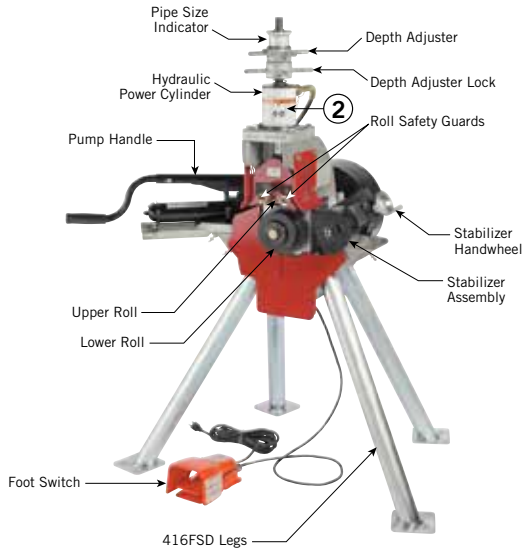

VE416FSD

RECEIVING TOOL

VE416FS tools are packed individually in sturdy containers, designed for use in reshipping tools upon completion of the rental contract, when applicable.

NOTE: Be sure to save original shipping container for return shipment of rental tools.

Upon receipt of tool, make sure all necessary parts are included. If any parts are missing, notify your Victaulic distributor or Victaulic representative.

VE416FS CONTAINER CONTENTS

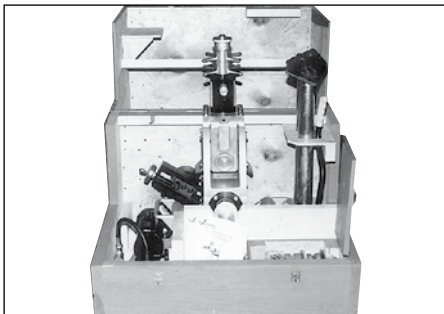

VE416FS SHOWN

VE416FS pallet should contain:

- A.** One small box which contains:
1. 2"-3½" roll set assembly.
- B.** One large box which contains:
1. Tool head/mounting stand assembly.
 2. Two (2) telescoping legs.
 3. Pump/pump support assembly.
 4. Pump handle.
 5. Roll storage chest with additional roll sizes.
 6. Two (2) Tool Operating and Maintenance Instruction Manuals

VE416FSD palletized box should contain:

1. VE416FSD tool includes: Tool head/stabilizer, mounting table/gear motor, hand pump, pump support, four (4) legs and foot switch with cord.

2. Box containing 2 - 3½" roll set assembly.
3. Roll storage chest with additional roll sizes.
4. Pump handle.
5. Two (2) Tool Operating and Maintenance Instruction Manuals.

Series 416 tools are supplied complete with 2" through 16" standard groove roll sets (with 8" to 12" rolls installed on the tool), unless otherwise specified on the order. Check order and rolls on tool to be sure. Rolls are marked with size and part number for your convenience. For grooving to other specifications and other materials, see Tool Rating and Roll Selection chart on pages 29 and 30. Grooving rolls for other specifications and other materials must be purchased separately.

TOOL SETUP

WARNING

- Do not connect power until instructed otherwise.

Accidental start up of tool may result in serious injury.

VE416FS

Before grooving, the tool head and legs must be mounted on a Victaulic VPD752 or a Ridgid 300 power drive. The tool and power drive must be placed on level ground and secured to a platform or floor. See Operator Safety Instructions Tool Setup on page 2.

WARNING

- During tool set-up, one person cannot safely handle the tool head assembly because it weighs 150 lbs. At least two people are needed to safely handle the assembly. If a hoist is available, use it to lift the tool head assembly into position.

Failure to follow this instruction may result in serious injury.

1. Remove all the components and check to be sure all necessary items are included. See list under Receiving Tool.

2. Select location for power drive, tool, and pipe stand. Choose a location that has:

- a. The required power. Consult power drive manufacturer's instructions.
- b. The space necessary to adequately handle the pipe to be grooved.
- c. A level and even surface for power drive, tool, pipe stand and footing.

3. Prepare the power drive unit to receive the VE416FS tool. Remove threading dies, cut off attachments, etc. from the power drive. Fully extend the two (2) tubular arms approximately 9¾" beyond the power drive chuck. See photo below. Secure the support arms in this position. (Consult power drive manufacturer's instructions.)

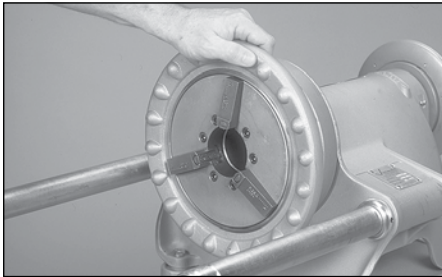
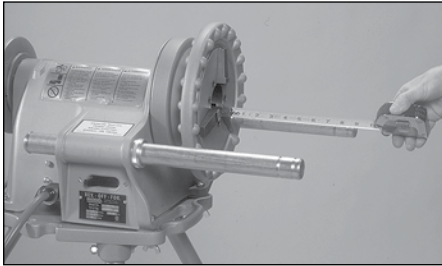

4. Fully open the power drive chuck (Consult power drive manufacturer's instructions).

WARNING

- While the tool head assembly is on power drive arms, without support legs installed, it is front heavy and may tip over. Have someone push back on tool head to help prevent a tip over - until legs are in place and secure.

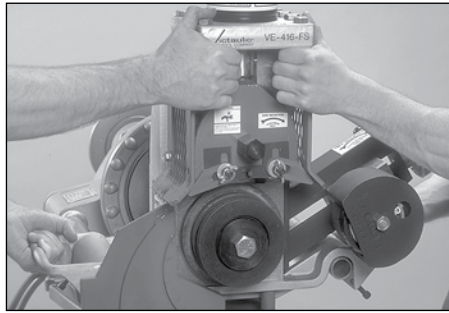

5. Slide tool head/mounting stand assembly as shown fully onto the power drive arms with drive lug flange flush up against power drive chuck.

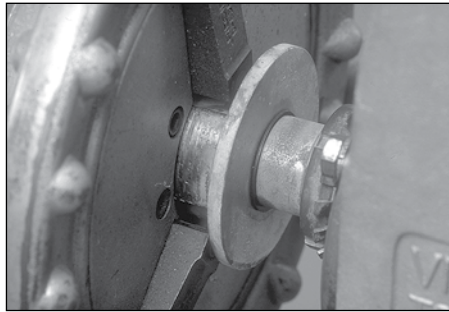

6. Align notched portions of drive shaft with the chuck jaws by turning the lower roll.

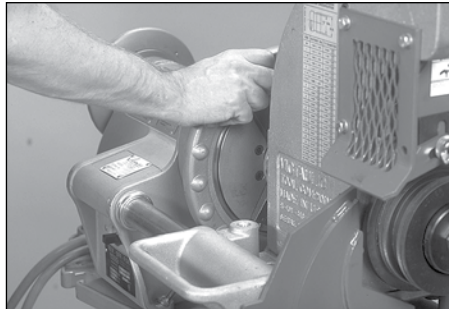

7. Tighten the chuck, making sure the jaws fit in the drive shaft notches.



8. Tighten the four (4) set screws as shown to secure the tool on the support arms.

9. Install the two (2) adjustable legs completely into the sockets of the upper leg and finger tighten the hex bolts.

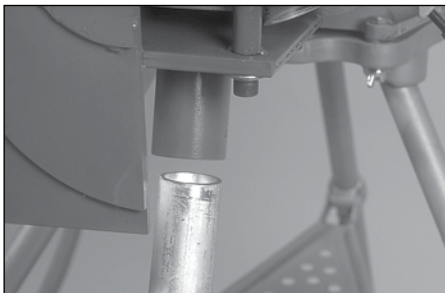

10. Insert top of leg assembly fully into the socket under tool head assembly. Rotate the assembly so it fully seats in the socket. The hex head bolts on the legs should be toward the back of the machine (toward power drive). Tighten hex head bolt using a wrench.



11. Level the tool front to back. The top of the cylinder mounting plate is a good location to measure level.



12. Loosen hex bolts to release lower legs (2) and allow them to drop down to floor. Turn leg pads at bottom until they are resting flat on the floor and tighten hex bolts with the tool in a level position.

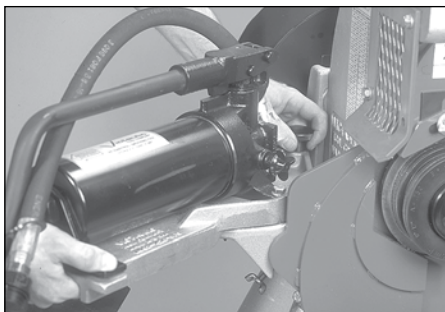

13. Mount the hand pump/pump support assembly. Tighten the hand knob and then tighten the wing set screw on the underside of the pump support as shown.



14. Connect the hydraulic hose from the hand pump to the power cylinder using the quick connections provided.



15. Insert the hand pump handle into lever arm of the pump. Position handle with handle grip down. Lock handle in this position with set screw or nut and bolt provided.

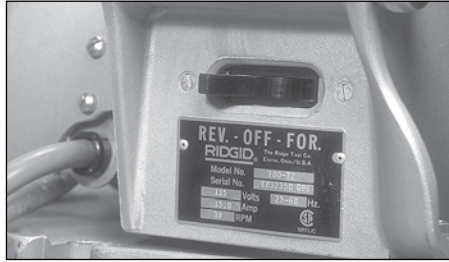

17. Turn the power drive switch to the position that will produce clockwise rotation of the chuck when viewed from the front of the tool. On the Victaulic VPD752 and Ridgid 300, putting the switch in the reverse position will produce clockwise rotation of the chuck, lower roll and pipe. Depress foot switch and check rotational direction and tool stability. If rotation is counterclockwise, reverse power drive switch. If tool wobbles, check to make certain tool is mounted squarely in chuck and tool is level. If the wobble cannot be eliminated, the power drive support arms are bent, or the power drive is damaged. Take the necessary steps to have power drive repaired if wobble persists.

18. Disconnect power. Turn power drive switch off or unplug power drive.

VE416FS tool setup is complete.

VE416FSD

⚠ DANGER



- To reduce the risk of electric shock, check the electrical source for proper grounding and follow the instructions below.

- Before performing any repair or maintenance, disconnect the tool from the electrical source.

Failure to do so could result in death or serious personal injury.

16. Make sure power drive is in its "Off" position (consult power drive manufacturer's instructions). Plug the power drive into an internally grounded electrical outlet. See Operator Safety Instructions Tool Set-Up on page 2. The outlet must meet the power requirements for the power drive (consult power drive manufacturer's recommendations). See page 4 for extension cord information, if used.

⚠ WARNING

- The power drive must be operated with a safety foot switch, as the operator will require it to operate the tool safely. If your power drive does not have a foot switch, contact power drive manufacturer.

⚠ WARNING

- Do not connect power until instructed otherwise.

Accidental start up of tool may result in serious injury.

1. Remove all the components and check to be sure all necessary items are included. See list under Receiving Tools.

2. Select location for tool, and pipe stand. Choose a location that has:

- The required power. Consult Power Requirements on page 3.
- The space necessary to adequately handle the pipe to be grooved.
- A level and even surface for power drive, tool, pipe stand and footing.

3. Place tool on level ground or platform and secure to the platform or floor. The tool's legs are adjustable in length to compensate for uneven surfaces. Adjust as necessary to maintain tool levelness.



4. Level the tool front to back. The top of the hydraulic ram is a good location to measure "level".



5. Insert the hand pump handle into lever arm of the pump. Position handle with handle grip down. Lock handle in this position with set screw or nut and bolt provided.

6. Tool setup is complete.

PRE-OPERATION ADJUSTMENTS

Every Vic-Easy tool is checked, adjusted and tested at the factory prior to shipment. Before grooving, however, the following adjustments should be made to make sure of proper tool operation.

WARNING

- Always turn off power before making any tool adjustments.

Accidental start up of tool may result in serious injury.

GROOVING ROLLS

Make sure the proper roll set is on the tool for the pipe size and material to be grooved. They are marked with the pipe size, part number and color coded for the pipe material to be grooved. See Tool Rating and Roll Selection Chart on pages 29 and 30. If proper rolls are not on tool, refer to Roll Changing on page 20.

CAUTION

- Make sure roll retaining bolts are tight. Loose retaining bolts could seriously damage both the tool and rolls.

PIPE PREPARATION

For proper tool operation, and production of proper pipe grooves, carefully observe the following pipe preparation tips.

1. Pipe ends must be square cut (See note for Column 2 on appropriate Groove Specification Chart, pages 32 - 35).
2. Internal or external weld bead or seams must be ground flush with the pipe surface extending 2" back from the pipe end.
3. The end of the pipe, both inside and out, must be cleaned of coarse scale, dirt and other foreign material.

CAUTION

- Foreign material such as coarse scale or dirt might interfere with or damage the grooving rolls or distort the groove. Rust is an abrasive material and will tend to wear out the surface of the grooving rolls. For maximum grooving roll life, remove foreign material and loose rust.

GROOVABLE PIPE LENGTHS

The VE416FS/FSD is capable of grooving short pipe lengths without the use of a pipe stand (see Table 1, on this page), or long pipe lengths up to double randoms (approximately 40 ft.), with the use of appropriate stands.

NOTICE

ALL VICTAULIC ROLL GROOVING TOOL OWNERS AND USERS
New Enhanced Tracking Rolls (ETR) for Victaulic Roll Grooving Tools

Enhanced Tracking Rolls (ETR)
In late 1993, Victaulic introduced an improved type of grooving roll called Enhanced Tracking Roll. The patented ETR allows hands-free grooving for short lengths of pipe as shown in Table 1. The photo below shows you the difference in appearance between the new ETR and the old type of roll. The new ETRs have two narrow grooves in the knurled surfaces; the older rolls do not.

ETRs are for the lower roll only. Your upper roll is compatible with the new ETR.

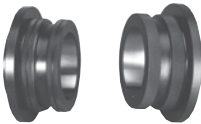

ETR Roll Old Type Roll

NOTE: Roll grooving short length pipe will place your hands close to the rollers. Using the old type of lower roll requires you to manually guide the pipe while grooving short lengths. Using the new ETR allows hand-free grooving.

Who has ETRs?

You may have ETRs if you:

- Purchased or rented a Victaulic roll grooving tool after December 1993
- Purchased replacement grooving rolls after December 1993

NOTE: It is important to figure out what type of grooving rolls you have. If you bought replacement rolls recently, you may have both types. If you do not have ETRs and would like to order them, contact Victaulic for details.

SHORT PIPE LENGTHS USING ETR ROLLS

Table 1 shows minimum and maximum pipe lengths that can be grooved without the need for a pipe stand. Refer to Grooving Operation on page 17 for instructions on how to groove short pipe lengths. For pipe longer than shown in Table 1, refer to Long Pipe Lengths, page 12.

WARNING

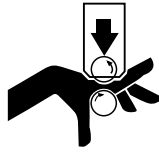

Grooving rolls can crush or cut fingers and hands.

- Loading and unloading pipe will place your hands close to the rollers.

- Never groove pipe shorter than what is recommended in Table 1 on this page.

TABLE 1 - GROOVABLE PIPE LENGTHS

DIMENSIONS – (Inches)					
Nom. Size	Min. Length	Max. Length	Nom. Size	Min. Length	Max. Length
2	8	36	6	10	28
2½	8	36	8 O.D.	10	24
3	8	36	8	10	24
3½	8	36	10	10	20
4	8	36	12	12	18
4½	8	32	14	12	16
5	8	32	16	12	16
6 O.D.	10	30			

If a pipe shorter than the minimum shown in Table 1 is needed, if possible, shorten the next to last piece of pipe enough so that the last piece of pipe is as long or longer than the minimum length specified in Table 1. See example below.

NOTICE

- Pipe nipples shorter than those shown in Table 1 are available from Victaulic.

Example: A 20 ft. 4 in. length of 10 in. diameter pipe is needed to finish a section and you only have 20 ft. lengths available. Instead of roll grooving a 20 ft. piece of pipe and a 4 in. piece of pipe, follow these steps:

- 1 Refer to Table 1 and note that for 10 in. diameter pipe, the minimum length that should be grooved is 10 in.
2. Roll groove a 19 ft. 6 in. piece of pipe and a 10 in. piece of pipe. Refer to Long Pipe Lengths on page 12.

LONG PIPE LENGTHS

With pipe in excess of the maximum length shown in Table 1, a roller type pipe stand must be used.

NOTICE

- Figure 1 shows the Victaulic adjustable pipe stand (VAPS 112). VAPS 112 is suitable for ¾" to 12" pipe. Also available is Victaulic model VAPS 224 suitable for sizes 2" to 24". See Accessories on page 27.

1. Place the pipe stand at a distance slightly beyond one half the pipe length from the tool (see Figure 1).

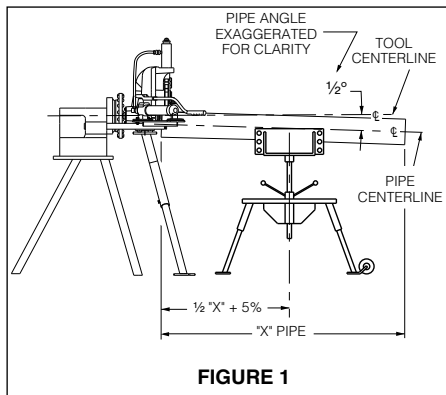

FIGURE 1

2. Position the pipe stand approximately $\frac{1}{2}^\circ$ to the left (tracking angle). See Figure 2.

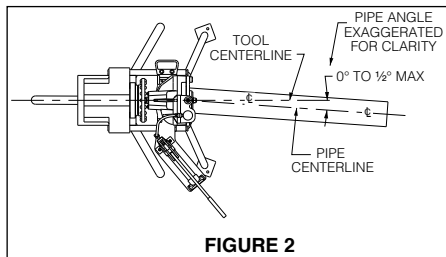

FIGURE 2

CAUTION

- "Tracking Angle" will affect pipe end flare. When pipe end flare is excessive, right-to-left tracking angle must be kept to a minimum. It may be necessary to use an angle less than $\frac{1}{2}^\circ$.

Pipe exceeding Maximum Allowable Flare, Column 8, Roll Groove Specifications, pages 32 - 35, may prevent assembly of couplings pad-to-pad, allowing possible pipe separation, and result in property damage. Also, joint leakage may result due to excessive gasket distortion/damage.

3. Adjust the pipe stand height to position the pipe approximately $\frac{1}{2}^\circ$ below level. See Figure 1. The pipe must be in position on the tool's lower roll while checking the below level position.

CAUTION

- Make sure tool is level (see Tool Set-Up). If pipe is grooved with back end of pipe (end of pipe which is not in tool) higher than the end being grooved, pipe may not track and pipe end flare may result.

Pipe exceeding Maximum Allowable Flare, Column 8, Roll Groove Specifications, pages 32 - 35, may prevent assembly of couplings pad-to-pad, allowing possible pipe separation, and result in property damage. Also, joint leakage may result due to excessive gasket distortion/damage.

NOTICE

- For additional information about pipe stands, refer to the Operating Instructions included with your pipe stand.

ROLL GUARD ADJUSTMENT

The VE416FS/FSD guards must be adjusted every time rolls are changed or pipe size or wall thickness is different from previous pipe grooved.

WARNING

- Always turn off power before making any tool adjustments.

Accidental start up of tool may result in serious injury.



1. Make sure the proper roll set is on the tool for the pipe size and material to be grooved. They are marked with the pipe size, part number and are color coded for pipe material for your convenience. See Tool Rating and Roll Selection on pages 29 and 30. If the proper rolls are not on the tool, refer to Roll Changing on page 20.

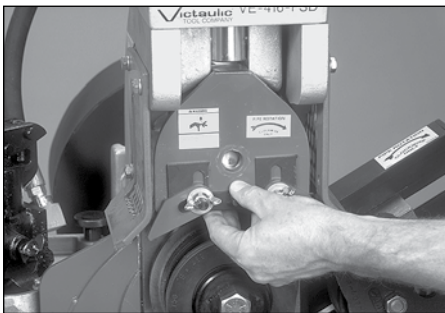

2. Loosen wing nuts and move the adjustable guards to the full up position. Tighten wing nuts.



3. Set groove diameter stop to pipe size and schedule/thickness to be grooved. To do this, back off the depth adjuster lock, align the depth adjuster with the proper diameter and thickness. Lock the depth adjuster in position with the depth adjuster lock.

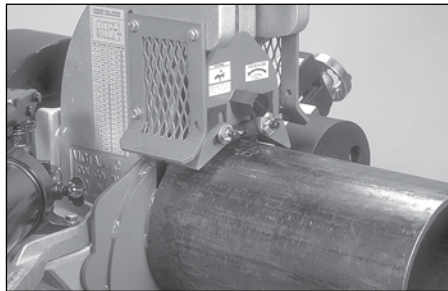

4. Insert a piece of pipe of the correct size and schedule/thickness to be grooved over the lower roll with the pipe end against the lower roll backstop flange. See Pipe Preparation on page 10.

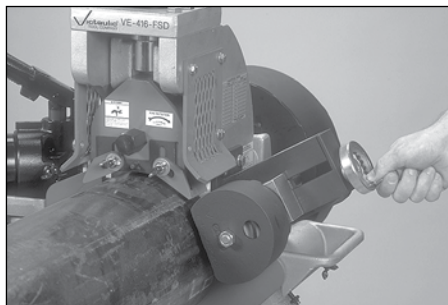

5. Retract stabilizer, if necessary, to insert pipe. To do this, loosen locking handle and retract stabilizer roller with the handwheel to clear pipe when inserted onto lower roll.

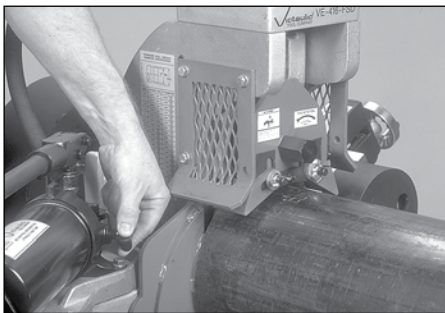

6. Close hand pump valve.

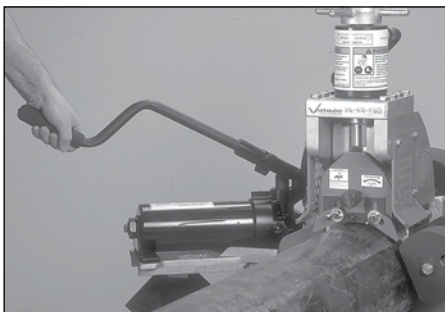

7. Pump upper roll down into firm contact with pipe.

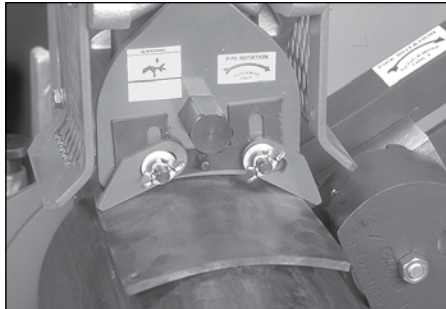

9. Loosen the wing nuts and adjust each guard to conform to and lightly pinch the pad against the pipe. Tighten wing nuts to secure guards in position.

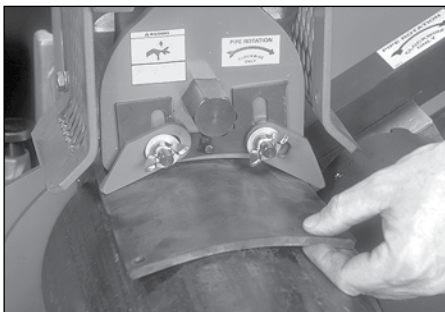

8. Remove the guard setting pad from its storage hook beneath the pump support. Hold the guard setting pad firmly down against the pipe and push it under the adjustable guards flush against the red plate.

10. Remove the guard setting pad. Store the pad back on the hook provided under pump base.

PIPE STABILIZER ADJUSTMENT

The Series 416 Pipe Stabilizer is designed to prevent pipe sway on 6" through 16" nominal IPS pipe sizes. This applies to short as well as long pipe. Once the stabilizer is adjusted for a selected pipe size and wall, it does not require further adjustment on that size. Pipe of the same size and wall may be moved in and out of the tool without retracting stabilizer.

WARNING

- Turn off power until instructed otherwise.
- Accidental start up of tool may result in serious injury.

ADJUSTMENT PROCEDURE

1. Make sure proper roll set is on the tool for the pipe size requiring grooving. Rolls are marked with pipe size and part number.

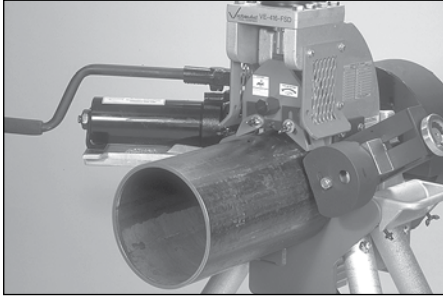

2. Insert a piece of pipe of the correct size and schedule to be grooved over the lower roll with the pipe end against the lower roll backstop flange.

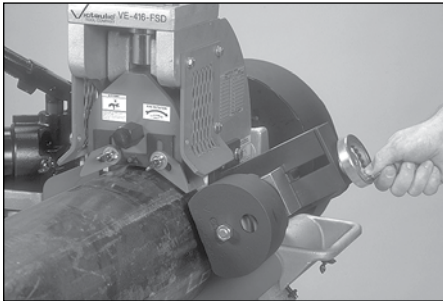

3. Loosen locking handle and retract stabilizer sufficiently with the hand wheel to clear pipe when inserted onto lower roll.

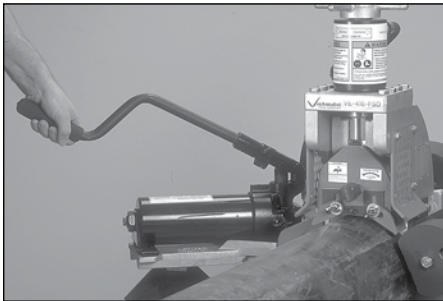

4. Close hand pump valve and pump upper roll down into firm contact with pipe.

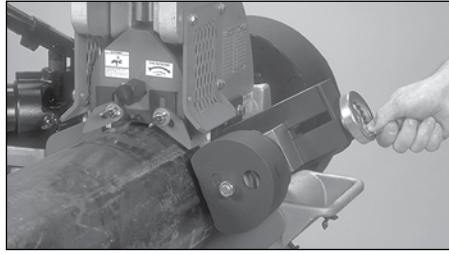

5. Advance stabilizer inward with hand wheel until stabilizer wheel lightly contracts pipe as shown, then tighten locking handle.

⚠ CAUTION

- Do not adjust stabilizer to push pipe to the left and off center from the rolls. Doing so will cause increased pipe end flare and shorten roller life.

Pipe exceeding Maximum Allowable Flare, Column 8, Roll Groove Specifications, pages 32 - 35, may prevent assembly of couplings pad-to-pad, allowing possible pipe separation and result in property damage. Also, joint leakage may result due to excessive gasket distortion/damage.

6. Complete the pre-operation adjustments and groove the pipe (see Grooving Operation on page 17). While grooving, observe the stabilizer wheel. It should remain in contact with the pipe at all times and the pipe should rotate smoothly without swaying from side to side. If not, advance stabilizer further inward. Retest and make further adjustments as necessary. Do not adjust stabilizer too far inward as it will skew the pipe to the left and possibly result in excessive pipe end flaring.

GROOVE DIAMETER STOP ADJUSTMENT

The groove diameter stop must be adjusted for each pipe size or change in wall thickness. Groove diameter, identified as the "C" dimension for each pipe size, is listed under Standard Roll Groove Specifications, pages 32 - 35. For your convenience, a "C" Diameter Chart also is on the tool.

NOTICE

- To perform the following adjustments, use several short scrap sections of pipe (but not shorter than what is recommended in Table 1, page 11) of the proper material, diameter and thickness to be grooved.

To achieve proper diameter:

1. Determine the size and thickness of pipe to be grooved. See pipe dimensions page 31 to determine proper schedule.



2. Locate the proper size and schedule on the pipe size indicator above the hydraulic power cylinder. It is rotatable for easy viewing.



3. Back off the depth adjuster lock. Align the depth adjuster with the proper size and schedule as shown. Lock the depth adjuster in position with the depth adjuster lock.

NOTICE

- The markings provide a “coarse” groove diameter adjustment and are not “exact” groove diameter settings. Variations in actual pipe O.D.’s and wall thicknesses make it impossible to calibrate the diameter stop exactly.

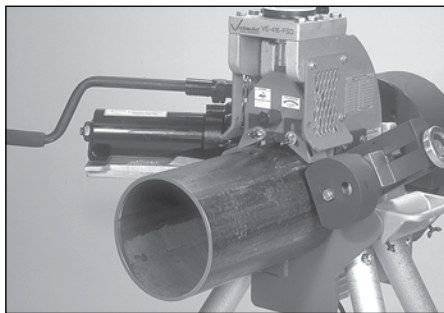

4. Using a piece of scrap pipe or short piece of pipe (refer to the Groovable Pipe Lengths Table on page 11) of the diameter and wall thickness to be grooved, place the pipe over the lower roll with the pipe end against the lower roll back stop flange.

WARNING

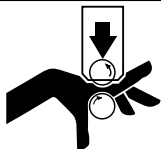

Grooving rolls can crush or cut fingers and hands.

- Keep hands away from grooving rolls and stabilizer wheel.
- Never reach inside pipe end or across the tool or pipe during operation.
- Always groove pipe in a clockwise direction only.
- Never groove pipe shorter than what is recommended.
- Never wear loose clothing, loose gloves, or jewelry while operating tool.

5. Prepare a trial groove. To do so, follow the Grooving Operation procedures outlined on page 17.

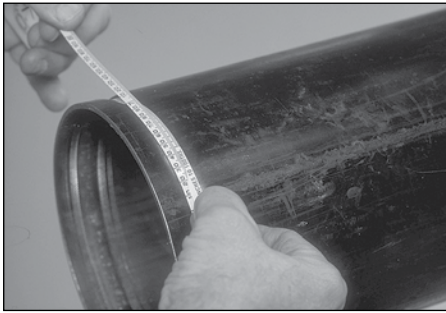

6. After a trial groove is prepared and pipe removed from the tool, carefully check the groove diameter (“C” dimension), as charted on pages 32 - 35 under Groove Specifications. The “C” dimension is best checked with a pipe tape. It also may be checked with a vernier caliper or narrow-land micrometer at two locations, 90° apart, around the groove. Average reading must equal the required groove diameter specification.

CAUTION

- The “C” dimension (groove diameter) must always conform to specifications under Roll Groove Specifications pages 32 - 35 to ensure proper joint performance.

Failure to do so could result in personal injury, property damage, improper installation, joint leakage or joint failure.

7. If groove diameter (“C” dimension) is not within tolerance, the diameter stop must be adjusted to obtain the proper dimension. To adjust for a **smaller groove diameter**, turn the depth adjuster **counterclockwise**. To adjust for a **bigger groove diameter**, turn adjuster **clockwise**. A quarter turn either way will change the groove diameter adjustment by 0.031” (0.125” per full turn).

8. Prepare another trial groove and check the groove diameter again (Steps 6 and 7) until groove diameter is within tolerance.

GROOVING OPERATION

CAUTION

- Vic-Easy Series VE416 tools are designed **ONLY** for roll grooving pipe of the sizes, materials and wall thicknesses outlined under Tool Rating and Roll Selection pages 29 and 30.

Grooving pipe other than that recommended will result in improper pipe end configuration or improper groove dimensions for applying Victaulic products.

Before grooving, make sure you have followed all instructions in:

- Tool Setup – Page 6
- Grooving Rolls – Page 10
- Pipe Preparation – Page 10
- Groovable Pipe Lengths – Page 11
- Roll Guard Adjustment – Page 13
- Pipe Stabilizer Adjustment – Page 14
- Groove Diameter Stop Adjust. – Page 15

WARNING



- Before operating tool, review all safety precautions on page 2.

Failure to do so may result in serious personal injury.

DANGER



- To reduce the risk of electric shock, check the electrical source for proper grounding and follow the instructions below.

Failure to do so could result in death or serious personal injury.

1. Plug the VE416FSD or power drive into an internally grounded electrical source. Make sure the VE416FSD or power drive is grounded. Consult power drive manufacturer’s instructions when using the VE416FS.

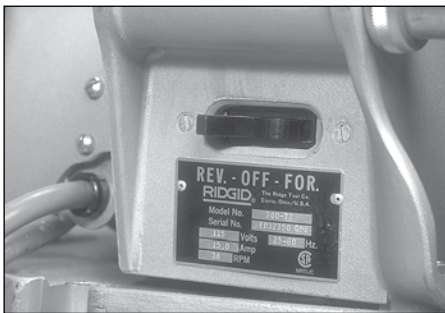

2. When using the VE416FS, set power drive switch to produce **clockwise** rotation of lower roll and pipe when viewed from front of tool. On the Victaulic VPD752 and Ridgid 300, **putting the switch in the REVERSE position will produce clockwise** rotation of the lower roll and pipe.

WARNING

- The power drive must be operated with a safety foot switch, as the operator will require it to operate the tool safely. If your power drive does not have a foot switch, contact power drive manufacturer.

3. Actuate foot switch by pressing foot on pedal to be certain tool is operational, power supply is available, and that lower roll is turning clockwise when viewed from the front. Remove foot from foot switch.

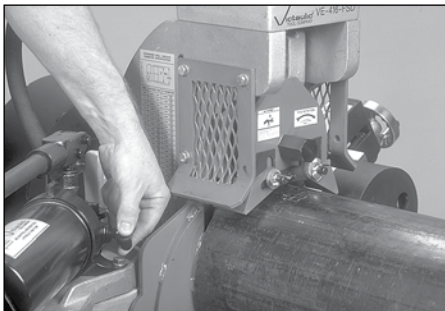

4. Open hydraulic pump pressure release valve by turning counterclockwise. This will allow upper roll to move to full up position.

WARNING

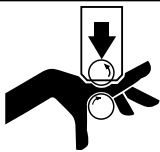

Grooving rolls can crush or cut fingers and hands.

- Keep hands away from grooving rolls and stabilizer wheel.

- Never reach inside pipe end or across the tool or pipe during operation.
- Always groove pipe in a clockwise direction only.
- Never groove pipe shorter than what is recommended.
- Never wear loose clothing, loose gloves, or jewelry while operating tool.

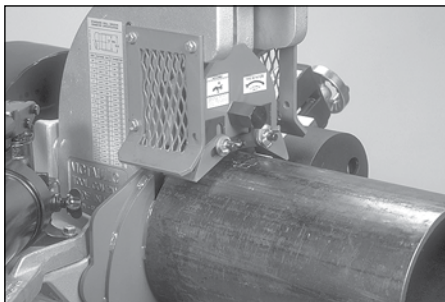

5. Insert a piece of pipe of the correct size and thickness to be grooved, onto the lower roll, with the pipe end squarely against the lower roll back-stop flange. If grooving a pipe supported by a pipe stand, remove hands from pipe.

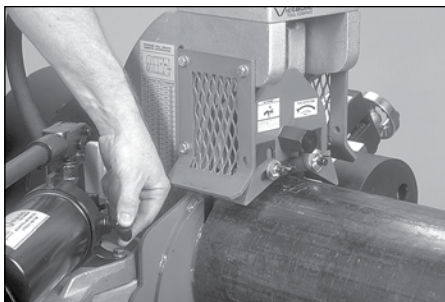

6. Close the pressure release valve on the pump by turning clockwise.



7. Operator should be positioned as shown.

8. Pump the handle several times to bring the upper roll into light but firm contact with the pipe.

9. If using ETR rolls (see Notice on page 11) when grooving a short pipe (see Table 1, page 11), remove hands from pipe.

10. If grooving a short piece of pipe (8" minimum length) with old type rolls (see Notice on page 11), pull the pipe to the left and downward with your right hand. Do not lift up on the pipe or push it to the right, as the pipe will not track and may spin (walk) out to the rolls. To initiate power depress and hold down the safety foot pedal switch. This will produce rotation of the lower roll which serves to rotate the pipe, which in turn rotates the upper roll. Check the tracking of the pipe as it rotates to be certain it remains snug against the lower roll back stop flange. If it does not, stop the tool rotation by releasing the safety pedal switch and check to be certain pipe is level and properly positioned.

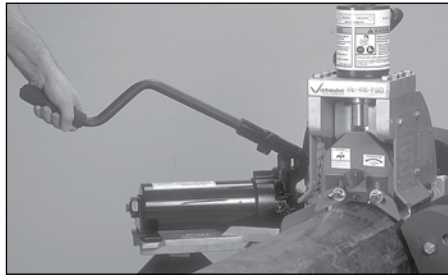

11. Depress and hold down foot switch. The pipe will begin to rotate clockwise. As the pipe rotates, begin grooving by slowly pumping the pump handle.

NOTICE

- **Do not pump too fast, but at a rate sufficient to groove the pipe and maintain audible moderate-to-heavy load on the tool or power drive motor.**



12. Continue grooving until the depth stop comes into full, firm contact with top of the hydraulic power cylinder. Continue pipe rotation for one (1) to three (3) revolutions to assure groove completion.

13. Release foot switch and withdraw foot from switch.

⚠ WARNING

- **Do not place hand(s) inside end of pipe to pull pipe out of tool or place hand(s) in area of grooving rolls or stabilizer roller.**

14. To remove a short piece of pipe after grooving is complete, support pipe.

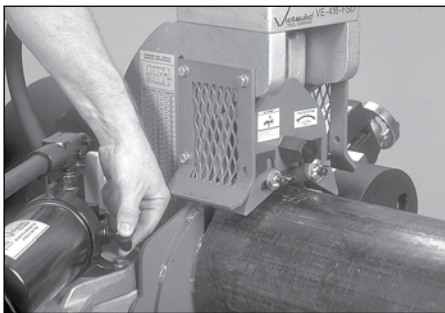

15. Open hydraulic release valve to release pipe. Remove pipe from tool.

NOTICE

- **Groove diameter should be correct for the diameter and wall thickness of pipe for which it was set under Groove Diameter Stop Adjustment. Groove diameter should be checked periodically and adjusted as necessary to assure grooves are within specification.**

ROLL CHANGING

WARNING

- **Always turn off power or unplug tool before making any tool adjustments.**

Accidental start-up of tool may result in serious injury.

ROLL REMOVAL 4 - 16"

Vic-Easy Series 416 roll grooving tools are designed for fast, easy grooving. Rolls accommodate several pipe sizes (refer to Tool Rating and Roll Selection on pages 29 and 30) eliminating the need for frequent roll changes. When a different size range is encountered or special grooving styles are required, the grooving rolls must be changed and Pre-Operation Adjustments re-performed. Also, different pipe materials may require that the rolls be changed. Refer to Tool Rating and Roll Selection, pages 29 and 30, for proper roll selection.

UPPER ROLL

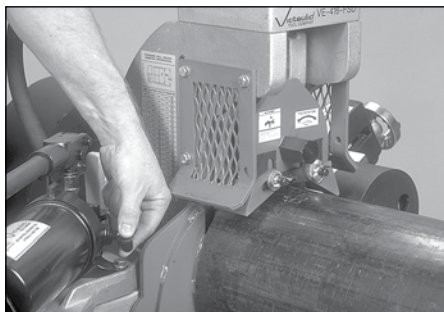

1. Open hand pump release valve (turn knob counterclockwise) which will move slide to the full open position.

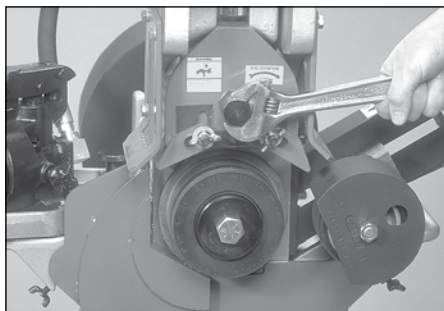

2. With a wrench, loosen and remove upper roll bolt and retaining plate as shown. Place on a clean surface.

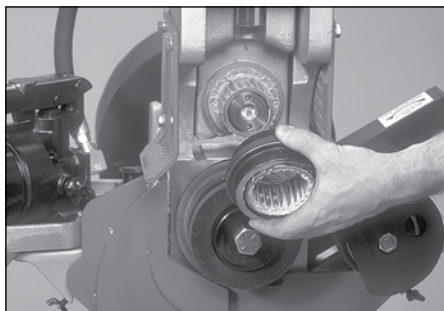

3. Slide the upper roll off the upper shaft as shown and store in the roll tote box supplied.

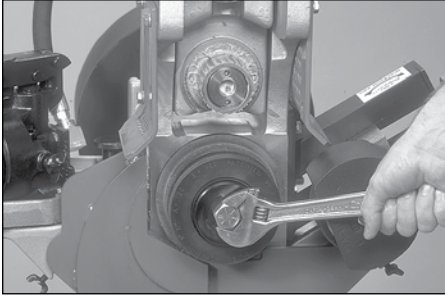
LOWER ROLL

1. Loosen and remove the bolt and retaining plate as shown. Place on a clean surface.

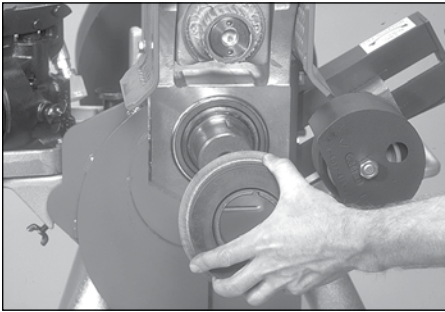

2. Slide the lower roll off the main shaft as shown and store in the roll tote box supplied.

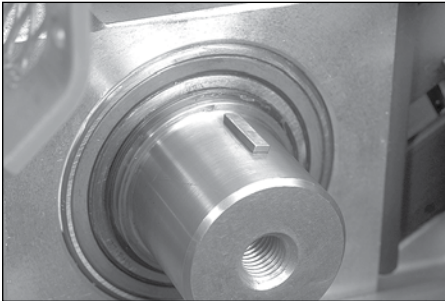
**NOTICE**

- Be careful not to lose the Woodruff Key. It should remain in the lower shaft. Inspect the Woodruff Key and replace if damaged.

ROLL INSTALLATION 4 - 16"

Clean upper shaft, main shaft and lower roll bore of any dirt and/or scale before installation of rolls. Inspect the roller bearing inside upper roll for proper lubrication and condition. Make repairs as necessary.

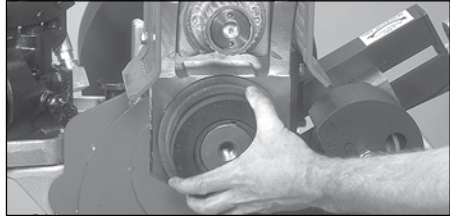
LOWER ROLL

1. Slide desired size lower roll fully onto main shaft with the marked side facing forward as shown. Make sure to properly align roll with the Woodruff Key on main shaft. NOTE: To aid in removing roll at a later time, you may apply a thin film of oil or grease (anti-seize lubricant) to the main shaft before installing the lower roll.

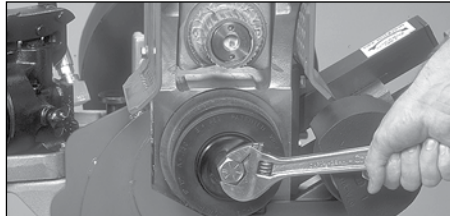

2. Install lower roll retaining plate (marked R-106-416-VEO) and bolt as shown. Securely tighten bolt with a wrench.

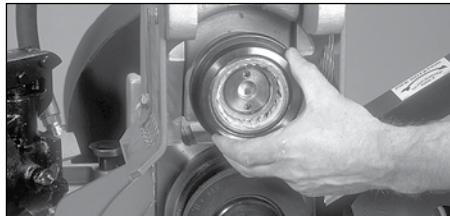
UPPER ROLL

1. Carefully slide desired size upper roll onto upper shaft as shown with markings facing forward.



2. Install upper roll retaining plate and bolt. Align tab on plate with recess in the slide as shown. Securely tighten bolt with a wrench.

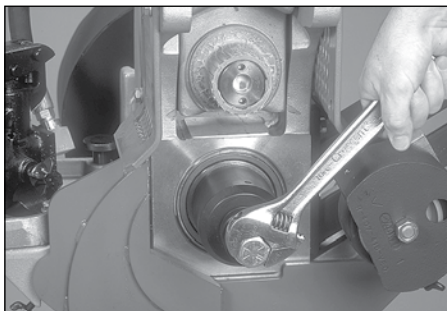

3. Place $\frac{3}{4}$ " flat washer (Part No. N-W01-120-000) onto $\frac{3}{4}$ " X $\frac{3}{4}$ " hex head cap screw (Part No. N-S02-120-304). Install bolt and washer as shown. Securely tighten bolt with a wrench.

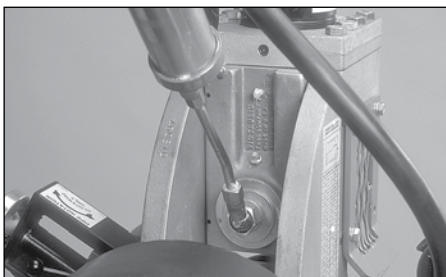

3. Lubricate upper roll bearing with a No. 2EP Lithium base grease as shown. Refer to maintenance section for additional information.

4. Roll installation is complete.

ROLL INSTALLATION 2 - 3½"

1. Remove existing rolls if necessary. Refer to 4"-16" upper and lower roll removal procedures (pages 20 and 21).

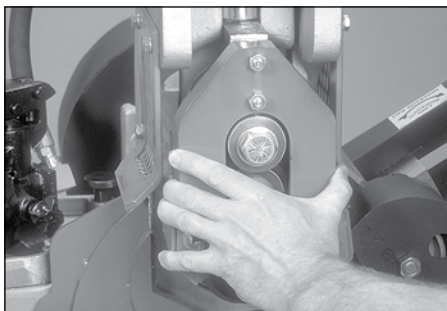

4. Carefully slide upper roll assembly onto upper shaft. Make sure to properly align the upper support block with the recess in the slide as shown.

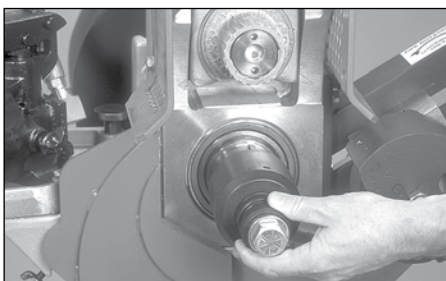

2. Lightly lubricate lower shaft with a thin film of oil or grease before installing the lower roll. Slide lower roll (Part No. R-902-416-L03) onto main shaft. Make sure to properly align roll with Woodruff Key on main shaft.

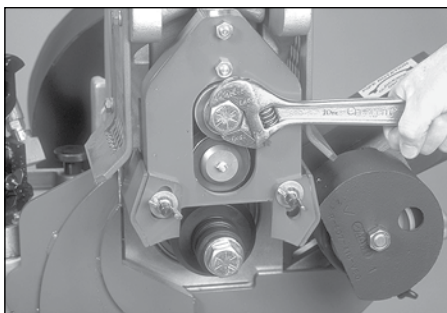

5. Thread the upper support block bolt (Part No. R-902-416-M03) into the upper shaft as shown. Tighten securely.

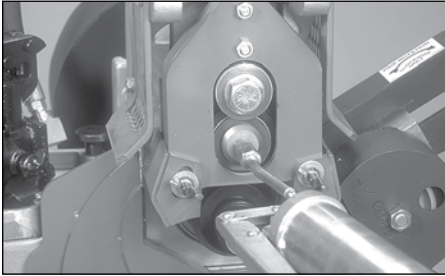

6. Lubricate the upper roll with No. 2EP Lithium base grease as shown. Refer to maintenance section for additional information.

NOTICE

- **As the upper support block bolt is tightened, it will draw the upper roll assembly into proper alignment with the lower roll.**

COPPER ROLL INSTALLATION 2 - 6" AND 8"

Installation and removal of 2 - 6" roll set for copper tubing is identical to installation and removal of standard roll set for 2 - 3½" steel pipe. See page 22.

Installation and removal of 8" roll set for copper tubing is identical to installation and removal of standard roll sets for 4 - 16" steel pipe. See page 21.

MAINTENANCE PROCEDURES

GENERAL

This manual provides information to permit the operator of Series 416 tools to keep his equipment in top operating condition and to guide him in making repairs when it becomes necessary.

Replacement parts, applicable only to these tools, should be ordered from Victaulic to assure proper operation of the tool. All special parts are FOB Easton, Pennsylvania, at the price in effect at the time of ordering.

NOTICE

- **Remember that preventative maintenance during operation will pay for itself in repair and operating savings.**

DANGER



- **Before performing any repair or maintenance, disconnect the tool from the electrical source to prevent accidental start up of tool.**

Failure to do so could result in death or serious personal injury.

After every eight hours of operation lubricate the tool. Always lubricate upper roll bearings when rolls are changed.

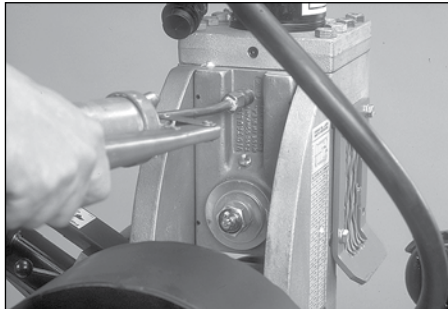

1. Grease slide gibbs. Two grease fittings are provided as shown.

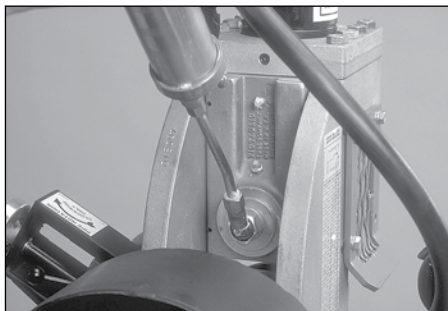

2. Grease upper roll bearing at fitting provided as shown.

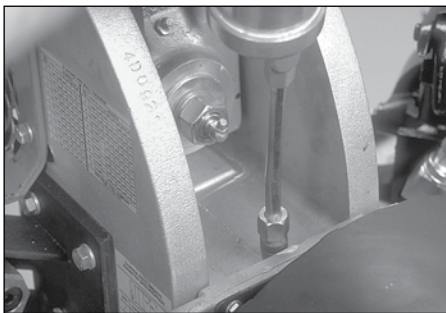

3. Grease main shaft bearings at fittings provided as shown.

VE416FSD ONLY LUBRICATION – MONTHLY



1. Lubricate drive gear as shown with a spray type heavy duty open gear lubricant (Lubriplate Gear Shield Extra Heavy or equivalent). To thoroughly lubricate, plug tool into proper outlet and jog drive gear around to several locations by depressing foot switch momentarily and then lubricating the gear at each position.

VE416FS AND VE416FSD HYDRAULIC SYSTEMS

The level of hydraulic fluid in the pump should be checked before operation and **must** be checked semi-annually or if pumping feels spongy.

FILLING AND CHECKING



1. Open pump release valve fully by turning counterclockwise.



2. Remove pump and mounting table from side of tool.

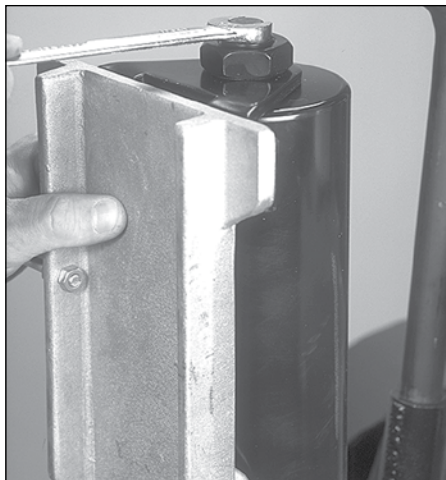

3. Loosen, but do not remove, the hydraulic fill plug/dipstick at the back end of the pump.

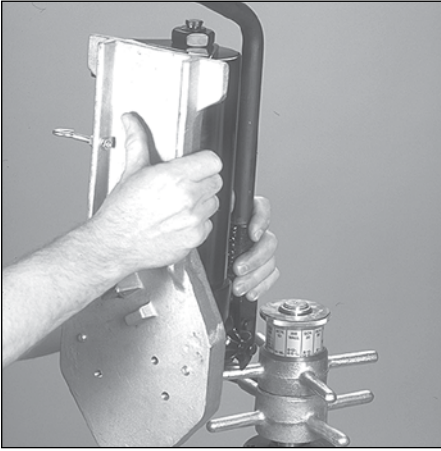

4. Hold pump so that fill plug end is ABOVE the hydraulic power cylinder. This will prevent siphoning of oil from the hydraulic power cylinder through pump.

5. Check fluid level. Add hydraulic jack oil to proper level as required. On models without dip stick, remove cap; oil should be approximately $\frac{1}{2}$ " to 1" from the end.

AIR BLEEDING

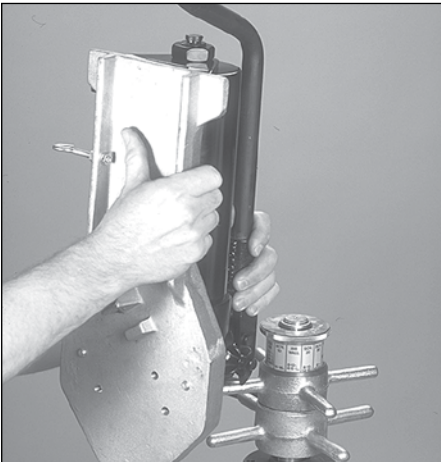

1. To bleed air from the system, hold the entire pump above the hydraulic power cylinder. Close the pump release valve by turning clockwise. Open fill plug one full turn.

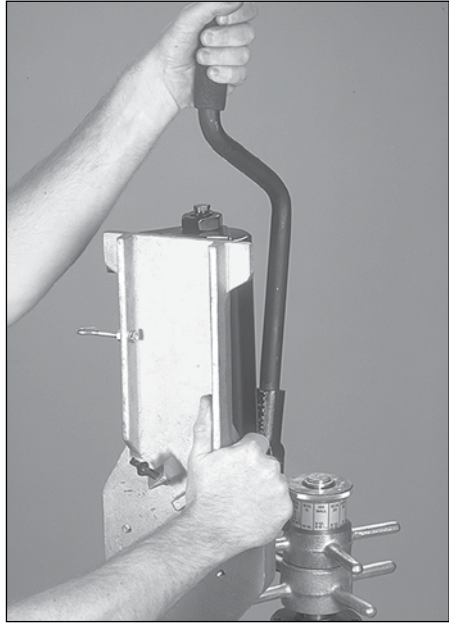

2. Pump the pump handle several strokes to build pressure.

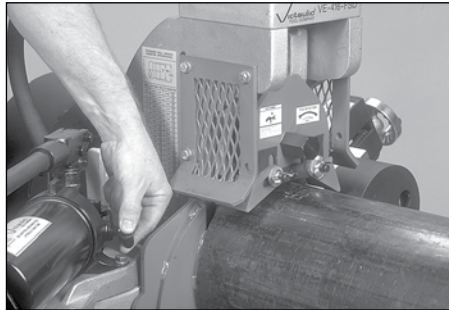

3. Open release valve by turning counterclockwise and allow air to escape.

4. Repeat steps 1-3 several times to bleed all the air from the system.

5. Check oil level and add oil if necessary.

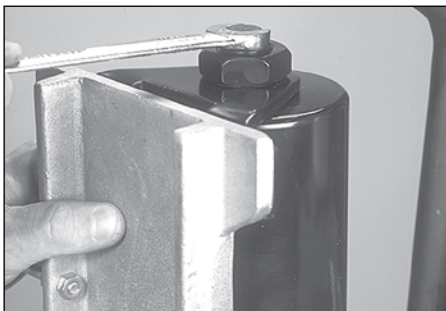

6. Continue to hold the pump above the hydraulic power cylinder and close the fill plug.



7. Replace the pump and table assembly securely to the side of the tool.

PARTS ORDERING INFORMATION

When ordering parts, the following information is necessary for Victaulic to process the order and send the correct part(s). Request RP-416FS/FSD for detail drawings and parts listing.

- (1) Tool Model Number. VE416FS or VE416FSD.
- (2) Tool Serial Number. The serial number can be found on the side of the tool head.
- (3) (Quantity), Part Number and Description.
For example: (1) Part #R-105-416-VEO, Upper Shaft.
- (4) Where to send the part (s):
Company name
Address
- (5) To whose attention to send the part(s).
Person's name
- (6) Purchase Order Number

Order parts from the nearest Victaulic sales office. Consult the back page of this Instruction Manual for the nearest Victaulic sales office.

ACCESSORIES

VICTAULIC ADJUSTABLE PIPE STANDS



Victaulic Model 112, a portable, adjustable, roller type, four-leg pipe stand for use with Series VE416 and other Victaulic roll grooving tools, is available from Victaulic. Ball transfer rollers, adjustable for pipe from $\frac{3}{4}$ - 12", will accommodate linear and rotational movement. Turnstile design permits easy swivel for grooving both pipe ends. Contact Victaulic for details.



Also available is Victaulic Model 224. It has features similar to Model 112. It is suitable for pipe sizes from 2 - 24". Consult Victaulic for details.

POWER DRIVE

The Victaulic VPD752 is available for use with VE416FS and other tools. Consult Victaulic for details.

OPTIONAL ROLLS

See Tool Rating and Roll Selection chart on pages 29 and 30 for rolls for different materials and groove specifications.

TROUBLESHOOTING

PROBLEM	POSSIBLE CAUSE	SOLUTION
Pipe will not stay in grooving rolls.	Incorrect pipe positioning on long pipes.	See "Groovable Pipe Lengths".
	Power drive running counterclockwise (VE416FS).	See "Tool Setup" (VE416FS).
Pipe stops rotating during grooving.	Rust or dirt has built up on lower roll.	Remove accumulation from lower roll with stiff wire brush.
	Worn grooving rolls.	Inspect lower roll for worn knurls, replace if worn.
	Lower roll key is sheared or missing.	Remove lower roll, replace key and install lower roll. See "Roll Changing".
	Power drive chuck is not engaged onto drive shaft.	See "Tool Setup".
	Power drive has stalled due to excess hand pumping.	Open release valve to free pipe, close release valve and continue grooving, pumping at a moderate rate.
	Circuit breaker has tripped or fuse has blown on electrical circuit supplying power drive.	Reset breaker or replace fuse.
While grooving, loud squeaks echo through the pipe.	Incorrect pipe support positioning on long pipes, pipe is "overtracking".	Move pipe support to the right. See "Long Pipe Lengths".
	Pipe not square cut.	Cut pipe end squarely.
	Pipe is rubbing excessively hard on lower roll flange.	Remove pipe from tool and apply a film of grease to the face of the lower roll flange as needed.
During grooving, loud thumps or bangs occur about once every revolution of the pipe.	Pipe has a pronounced weld seam.	Grind welds flush with pipe surface inside and out 2" back from pipe end.
Pipe flare is excessive.	Pipe support adjusted too high on long pipes.	See "Long Pipe Lengths".
	Tool is tilted forward while grooving long pipes.	See "Tool Setup".
	Incorrect pipe support positioning on long pipes, pipe is "overtracking".	Move pipe support to right. See "Long Pipe Lengths".
	Stabilizer is adjusted too far inward.	Back off stabilizer to the furthest point where it still stabilizes pipe effectively.
Pipe sways or vibrates from side to side.	Incorrect stabilizer adjustment.	Move stabilizer in or out until pipe rotates smoothly.
Tool won't groove pipe.	Hand pump valve is not closed tightly.	Tighten valve.
	Hand pump is low on oil.	See "Maintenance".
	Air in hydraulic system.	See "Maintenance".
	Pipe beyond tool's wall thickness capability.	See "Tool Rating and Roll Selection".

TOOL RATING AND ROLL SELECTION

STANDARD AND “ES” ROLLS – COLOR CODED BLACK

Nom. Size Inches/mm	1		2		3		4		Standard Roll Nos.	“ES” Roll Nos.
	Nominal Wall Thickness Dimensions – Inches/mm									
	Steel Pipe		Stainless Steel Pipe		Aluminum Pipe		PVC Plastic Pipe			
	Min.	Max.	Min.	Max.	Min.	Max.	Min.	Max.		
2	0.065	0.154	0.154	0.154	0.065	0.154	0.154	0.154	Lower Roll R902416L03	Lower Roll RZ02416L03
50	1.65	3.91	3.91	3.91	1.7	3.91	3.91	3.91		
2½	0.083	0.203	0.203	0.203	0.083	0.203	0.203	0.276	Upper Roll R9A2416U03	Upper Roll RZA2416U03
65	2.111	5.16	5.16	5.16	2.111	5.16	5.16	7.01		
3	0.083	0.216	0.216	0.216	0.083	0.216	0.216	0.300	Lower Roll R904416L06	Lower Roll RZ04416L06
80	2.11	5.49	5.49	5.49	2.11	5.49	5.49	7.62		
3½	0.083	0.226	0.226	0.226	0.083	0.226	0.226	0.318	Upper Roll R9A4416U06	Upper Roll RZA4416U06
90	2.11	5.74	5.74	5.74	2.11	5.74	5.74	8.07		
4	0.083	0.375	0.237	0.237	0.083	0.237	0.237	0.337	Lower Roll R908416L12	Lower Roll RZ08416L12
100	2.11	9.53	6.02	6.02	2.11	6.02	6.02	8.55		
4½	0.095	0.375	0.237	0.237	0.095	0.237	–	–	Upper Roll R9A8416U16	Upper Roll RZA8416U12
120	2.41	9.53	6.02	6.02	2.41	6.02	–	–		
5	0.109	0.375	0.258	0.258	0.109	0.258	0.258	0.375	Lower Roll R914416L16	–
125	2.77	9.53	6.55	6.55	2.77	6.55	6.55	9.53		
6 O.D.	0.109	0.375	0.258	0.258	0.109	0.258	–	–	Upper Roll R9A8416U16	Upper Roll RZA8416U12
	2.77	9.53	6.55	6.55	2.77	6.55	–	–		
6	0.109	0.375	0.280	0.280	0.109	0.280	0.280	0.432	Lower Roll R908416L12	Lower Roll RZ08416L12
150	2.77	9.53	7.11	7.11	2.77	7.11	7.11	10.97		
8 O.D.	0.109	0.375	0.250	0.322	0.109	0.322	–	–	Upper Roll R9A8416U16	Upper Roll RZA8416U12
	2.77	9.53	6.35	8.22	2.77	8.22	–	–		
8	0.109	0.375	0.250	0.322	0.109	0.322	0.322	0.500	Lower Roll R914416L16	–
200	2.77	9.53	6.35	8.22	2.77	8.22	8.22	12.70		
10	0.134	0.375	0.250	0.365	0.134	0.250	0.365	0.593	Upper Roll R9A8416U16	Upper Roll RZA8416U12
250	3.4	9.53	6.35	9.27	3.40	6.35	9.27	15.06		
12	0.156	0.375	0.250	0.375	0.156	0.250	0.406	0.687	Lower Roll R914416L16	–
300	4.0	9.53	6.35	9.53	3.96	6.35	10.3	17.45		
14	0.156	0.375	0.312	0.375	–	–	0.438	0.438	Upper Roll R9A8416U16	–
350	3.96	9.53	7.92	9.53	–	–	11.13	11.13		
15 O.D.	0.165	0.375	0.312	0.375	–	–	–	–	Lower Roll R914416L16	–
	4.19	9.53	7.92	9.53	–	–	–	–		
16	0.165	0.375	0.312	0.375	–	–	0.500	0.500	Upper Roll R9A8416U16	–
450	4.19	9.53	7.92	9.53	–	–	12.70	12.70		

Notes for Standard and “ES” Rolls:

COLUMN 1: Maximum ratings on steel are limited to pipe of 180 BHN (Brinell Hardness Number) and less.

COLUMN 2: Types 304 and 316

COLUMN 3: Alloys 6061-T4 and 6063-T4

COLUMN 4: PVC Type I Grade I - PVC1120; PVC Type I Grade II - PVC1220; PVC Type II Grade I - PVC2116

**ROLLS FOR SCHEDULE 5S AND 10S STAINLESS STEEL PIPE †
(RX ROLLS) – CHROME PLATED**

Nominal Size Inches/mm	Nominal Stainless Steel Pipe Wall Thickness Inches/mm			RX Roll Nos.	
	Sch. 5S	Sch. 10S	Sch. 10		
2 50	0.065 1.7	0.109 2.8	– –	Lower Roll RX02416L03	Upper Roll RXA2416U03
2½ 65	0.083 2.1	0.120 3.0	– –		
3 80	0.083 2.1	0.120 3.0	– –		
3½ 90	0.083 2.1	0.120 3.0	– –		
4 100	0.083 2.1	0.120 3.0	– –	Lower Roll RX04416L06	Upper Roll RXA4416U06
5 125	0.109 2.8	0.134 3.4	– –		
6 150	0.109 2.8	0.134 3.4	– –	Lower Roll RX08416L12	Upper Roll RXA8416U16
8 200	0.109 2.8	0.148 3.8	– –		
10 250	0.134 3.4	0.165 4.2	– –		
12 300	0.156 4.0	0.180 4.6	– –		
14 350	0.156 3.96	0.188 4.77	0.250 6.35	Lower Roll RX14416L16	Upper Roll RXA8416U16
16 450	0.165 4.19	0.188 4.77	0.250 6.35		

† Types 304 and 316.

ROLLS FOR COPPER TUBING – COLOR CODED COPPER †

Nominal Size Inches/mm	Nominal Copper Tubing Wall Thickness Inches/mm		Copper Roll Nos.	
	Min.	Max.		
2 50	0.042 1.1	0.083 2.1	Lower Roll RR02416L06	Upper Roll RRA2416U06
2½ 65	0.065 1.7	0.095 2.4		
3 80	0.045 1.1	0.109 2.8		
4 100	0.058 1.5	0.134 3.4		
5 125	0.072 1.8	0.160 4.1		
6 150	0.083 2.1	0.192 4.9		
8 200	0.109 2.8	0.271 6.9	Lower Roll RR08416L08	Upper Roll RRA8416U08

† Drawn copper tubing – DWV, ASTM B306 - Type "M", ASTM B88 – Type "L", ASTM B88 – Type "K", ASTM B88.
Rolls are available for grooving British Standard, Australian Standard and DIN Standard copper tube, contact Victaulic for details.

DIMENSIONS

SEAMLESS AND WELDED STEEL PIPE

Nominal Size Inches mm	Pipe O.D. Inches mm	Nominal Wall Thickness – Inches/mm							
		Sch. 5S	Sch. 10S	Sch. 10	Sch. 20	Sch. 30	Sch. 40	Sch. STD.	Sch. 80
2 50	2.375 60.3	0.065 1.7	0.109 2.8	— —	— —	— —	0.154 3.9	0.154 3.9	0.218 5.5
2½ 65	2.875 73.0	0.083 2.1	0.120 3.0	— —	— —	— —	0.203 5.2	0.203 5.2	0.276 7.0
3 80	3.500 88.9	0.083 2.1	0.120 3.0	— —	— —	— —	0.216 5.5	0.216 5.5	0.300 7.6
3½ 90	4.000 101.6	0.083 2.1	0.120 3.0	— —	— —	— —	0.226 5.7	0.226 5.7	0.318 8.1
4 100	4.500 114.3	0.083 2.1	0.120 3.0	— —	— —	— —	0.237 6.0	0.237 6.0	0.337 8.6
5 125	5.563 141.3	0.109 2.8	0.134 3.4	— —	— —	— —	0.258 6.6	0.258 6.6	0.375 9.5
6 150	6.625 168.3	0.109 2.8	0.134 3.4	— —	— —	— —	0.280 7.1	0.280 7.1	0.432 11.0
8 200	8.625 219.1	0.109 2.8	0.148 3.8	— —	0.250 6.4	0.277 7.0	0.322 8.2	0.322 8.2	0.500 12.7
10 250	10.750 273.0	0.134 3.4	0.165 4.2	— —	0.250 6.4	0.307 7.8	0.365 9.3	0.365 9.3	0.594 15.1
12 300	12.750 323.9	0.156 4.0	0.180 4.6	— —	0.250 6.4	0.330 8.4	0.406 10.3	0.375 9.5	0.688 17.4
14 350	14.000 350	0.156 4.0	0.188 4.8	0.250 6.4	0.312 7.9	0.375 9.5	0.437 11.1	0.375 9.5	0.750 19.0
16 450	16.000 450	0.165 4.2	0.188 4.8	0.250 6.4	0.312 7.9	0.375 9.5	0.500 12.7	0.375 9.5	0.843 21.4

DRAWN COPPER TUBING

Nominal Tube Size Inches mm	Outside Diameter	Nominal Wall Thickness – Inches/mm			
		DWV ASTM B-306	Type "M" ASTM B-88	Type "L" ASTM B-88	Type "K" ASTM B-88
2 50	2.125 54.0	0.042 1.1	0.058 1.5	0.070 1.8	0.083 2.1
2½ 65	2.625 66.7	— —	0.065 1.7	0.080 2	0.095 2.4
3 80	3.125 79.4	0.045 1.1	0.072 1.8	0.090 2.3	0.109 2.8
4 100	4.125 104.8	0.058 1.5	0.095 2.4	0.110 2.8	0.134 3.4
5 125	5.125 130.2	0.072 1.8	0.109 2.8	0.125 3.2	0.160 4.1
6 150	6.125 155.6	0.083 2.1	0.122 3.1	0.140 3.6	0.192 4.9
8 200	8.125 206.4	0.109 2.8	0.170 4.3	0.200 5.1	0.271 6.9

ROLL GROOVE SPECIFICATIONS

**STEEL PIPE AND ALL MATERIALS
GROOVED WITH STANDARD AND "RX" ROLLS**

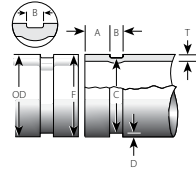

1	2		3	4	5		6	7	8	
Nom. Pipe Size In./mm	Dimensions – Inches/millimeters									
	Pipe Outside Dia.			Gasket Seat A ±0.03 ±0.76	Groove Width B ±0.03 ±0.76	Groove Dia. C		Grv. Depth D (ref.)	Nom. Min. Allow. Wall Thk. T	Max. Allow. Flare Dia.
	Basic	Tolerance + -				Basic	Tol. +0.000 +0.00			
2 50	2.375 60.3	0.024 0.61	0.024 0.61	0.625 15.88	0.344 8.74	2.250 57.15	-0.015 -0.38	0.063 1.60	0.065 1.65	2.48 63.0
2½ 65	2.875 73.0	0.029 0.74	0.029 0.74	0.625 15.88	0.344 8.74	2.720 69.09	-0.018 -0.46	0.078 1.98	0.083 2.11	2.98 75.7
3 O.D.	3.000 76.1	0.030 0.76	0.030 0.76	0.625 15.88	0.344 8.74	2.845 72.26	-0.018 -0.46	0.078 1.98	0.083 2.11	3.10 78.7
3 80	3.500 88.9	0.035 0.89	0.031 0.79	0.625 15.88	0.344 8.74	3.344 84.94	-0.018 -0.46	0.078 1.98	0.083 2.11	3.60 91.4
3½ 90	4.000 101.6	0.040 1.02	0.031 0.79	0.625 15.88	0.344 8.74	3.834 97.38	-0.020 -0.51	0.083 2.11	0.083 2.11	4.10 104.1
4½ O.D.	4.250 108.0	0.043 1.04	0.031 0.79	0.625 15.88	0.344 8.74	4.084 103.73	-0.020 -0.51	0.083 2.11	0.083 2.11	4.35 110.5
4 100	4.500 114.3	0.045 1.14	0.031 0.79	0.625 15.88	0.344 8.74	4.334 110.08	-0.020 -0.51	0.083 2.11	0.083 2.11	4.60 116.8
4½ 120	5.000 127.0	0.050 1.27	0.031 0.79	0.625 15.88	0.344 8.74	4.834 122.78	-0.020 -0.51	0.083 2.11	0.095 2.41	5.10 129.5
5¼ O.D.	5.250 133.0	0.053 1.70	0.031 0.79	0.625 15.88	0.344 8.74	5.084 129.13	-0.020 -0.51	0.083 2.11	0.109 2.77	5.35 135.9
5½ O.D.	5.500 139.7	0.056 1.42	0.031 0.79	0.625 15.88	0.344 8.74	5.334 135.48	-0.020 -0.51	0.083 2.11	0.109 2.77	5.60 142.2
5 125	5.563 141.3	0.056 1.42	0.031 0.79	0.625 15.88	0.344 8.74	5.395 137.03	-0.022 -0.56	0.084 2.13	0.109 2.77	5.66 143.8
6 O.D.	6.000 152.4	0.056 1.42	0.031 0.79	0.625 15.88	0.344 8.74	5.830 148.08	-0.022 -0.56	0.085 2.16	0.109 2.77	6.10 154.9
6¼ O.D.	6.250 159.0	0.063 1.60	0.031 0.79	0.625 15.88	0.344 8.74	6.032 153.21	-0.030 -0.56	0.085 2.16	0.109 2.77	6.35 161.3
6½ O.D.	6.500 165.1	0.063 1.60	0.031 0.79	0.625 15.88	0.344 8.74	6.330 160.78	-0.022 -0.56	0.085 2.16	0.109 2.77	6.60 167.6
6 150	6.625 168.3	0.063 1.60	0.031 0.79	0.625 15.88	0.344 8.74	6.455 163.96	-0.022 -0.56	0.085 2.16	0.109 2.77	6.73 170.9
8 O.D.	8.000 203.2	0.063 1.60	0.031 0.79	0.750 19.05	0.469 11.91	7.816 198.53	-0.025 -0.64	0.092 2.34	0.109 2.77	8.17 207.5
8 200	8.625 219.1	0.063 1.60	0.031 0.79	0.750 19.05	0.469 11.91	8.441 214.40	-0.025 -0.64	0.092 2.34	0.109 2.77	8.80 223.5
10 O.D.	10.000 254.0	0.063 1.60	0.031 0.79	0.750 19.05	0.469 11.91	9.812 249.23	-0.027 -0.69	0.094 2.39	0.134 3.40	10.17 258.3

Table continued on page 33. See column notes on page 33.

ROLL GROOVE SPECIFICATIONS (CONT.)

STEEL PIPE AND ALL MATERIALS

GROOVED WITH STANDARD AND "RX" ROLLS

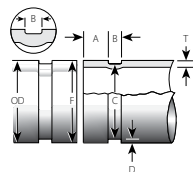

1	2		3	4	5		6	7	8	
Nom. Pipe Size In./mm	Dimensions – Inches/millimeters									
	Pipe Outside Dia.			Gasket Seat A ±0.03 ±0.76	Groove Width B ±0.03 ±0.76	Groove Dia. C		Grv. Depth D (ref.)	Nom. Min. Allow. Wall Thk. T	Max. Allow. Flare Dia.
	Basic	Tolerance +				Basic	Tol. +0.000 +0.00			
10 250	10.750 273.0	0.063 1.60	0.031 0.79	0.750 19.05	0.469 11.91	10.562 268.28	-0.027 -0.69	0.094 2.39	0.134 3.40	10.92 277.4
12 O.D.	12.000 304.8	0.063 1.60	0.031 0.79	0.750 19.05	0.469 11.91	11.781 299.24	-0.030 -0.76	0.109 2.77	0.156 3.96	12.17 309.1
12 300	12.750 323.9	0.063 1.60	0.031 0.79	0.750 19.05	0.469 11.91	12.531 318.29	-0.030 -0.76	0.109 2.77	0.156 3.96	12.92 328.2
14 O.D.	14.000 355.6	0.063 1.60	0.031 0.79	0.938 23.83	0.469 11.91	13.781 350.04	-0.030 -0.76	0.109 2.77	0.156 3.96	14.10 358.1
15 O.D.	15.000 381.0	0.063 1.60	0.031 0.79	0.938 23.83	0.469 11.91	14.781 375.44	-0.030 -0.76	0.109 2.77	0.165 4.19	15.10 383.5
16 O.D.	16.000 406.4	0.063 1.60	0.031 0.79	0.938 23.83	0.469 11.91	15.781 400.84	-0.030 -0.76	0.109 2.77	0.165 4.19	16.10 408.9

STANDARD ROLL GROOVE SPECIFICATION NOTES:

COLUMN 1: Nominal IPS Pipe size.

COLUMN 2: IPS outside diameter. The outside diameter of roll grooved pipe shall not vary more than the tolerance listed. For IPS pipe the maximum allowable tolerance from square cut ends is 0.030" for ¾ - 3½"; 0.045" for 4 - 6"; and 0.060" for sizes 8" O.D. and above measured from true square line.

COLUMN 3: Gasket seat. The pipe surface shall be free from indentations, roll marks, and projections from the end of the pipe to the groove, to provide a leak-tight seal for the gasket. All loose paint, scale, dirt, chips, grease and rust must be removed. It continues to be Victaulic's first recommendation that pipe be square cut. When using beveled pipe contact Victaulic for details. Square cut pipe must be used with FlushSeal® and EndSeal® gaskets. Gasket seat "A" is measured from the end of the pipe. IMPORTANT: Roll grooving of beveled end pipe may result in unacceptable pipe end flare. See column 8.

COLUMN 4: Groove width. Bottom of groove to be free of loose dirt, chips, rust and scale that may interfere with proper coupling assembly. Corners at bottom of groove must have a radius of the following dimensions. For IPS steel pipe, .06R on ¾ - 1½", .08R on 2 - 6", .05R on 8" and up.

COLUMN 5: Groove outside diameter. The groove must be of uniform depth for the entire pipe circumference. Groove must be maintained within the "C" diameter tolerance listed.

COLUMN 6: Groove depth. For reference only. Groove must conform to the groove diameter "C" listed.

COLUMN 7: Minimum allowable wall thickness. This is the minimum wall thickness which may be roll grooved – except PVC.

COLUMN 8: Maximum allowable pipe end flare diameter. Measured at the most extreme pipe end diameter square cut or beveled.

ROLL GROOVE SPECIFICATIONS

STEEL PIPE AND ALL MATERIALS GROOVED WITH "ES" ROLLS

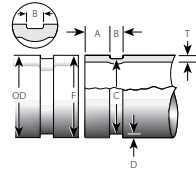

1	2		3		4		5		6	7	8	
	Dimensions – Inches/millimeters											
	Pipe Outside Dia. O.D.		Gasket Seat A		Groove Width B		Groove Dia. C		Grv. Depth (ref.) D	Nom. Min. Allow. Wall Thick. T	Max. Allow. Flare Dia.	
Nom. Size In. mm	Basic	Tolerance + -	Basic	Tol. +0.000 +0.00	Basic	Tol. -0.000 -0.00	Basic	Tol. +0.000 +0.00				
	2 50	2.375 60.3	+0.024 +0.61	-0.024 -0.61	0.572 14.53	-0.020 -0.51	0.250 6.35	+0.015 +0.38	2.250 57.15	-0.015 -0.38	0.063 1.60	0.065 1.65
2½ 65	2.875 73.0	+0.029 +0.74	-0.029 -0.74	0.572 14.53	-0.020 -0.51	0.250 6.35	+0.015 +0.38	2.720 69.09	-0.018 -0.46	0.078 1.98	0.083 2.11	2.98 75.7
3 80	3.500 88.9	+0.035 +0.89	-0.031 -0.79	0.572 14.53	-0.020 -0.51	0.250 6.35	+0.015 +0.38	3.344 84.94	-0.018 -0.46	0.078 1.98	0.083 2.11	3.60 78.7
4 100	4.500 114.3	+0.045 +1.14	-0.031 -0.79	0.610 15.49	-0.020 -0.51	0.300 7.62	+0.020 +0.51	4.334 110.08	-0.020 -0.51	0.083 2.11	0.083 2.11	4.60 116.8
6 150	6.625 168.3	+0.063 +1.60	-0.031 -0.79	0.610 15.49	-0.020 -0.51	0.300 7.62	+0.020 +0.51	6.455 163.96	-0.022 -0.56	0.085 2.16	0.109 2.77	6.73 170.9
8 200	8.625 219.1	+0.063 +1.60	-0.031 -0.79	0.719 18.26	-0.020 -0.51	0.390 9.91	+0.020 +0.51	8.441 214.40	-0.025 -0.64	0.092 2.34	0.109 2.77	8.80 223.5
10 250	10.750 273.0	+0.063 +1.60	-0.031 -0.79	0.719 18.26	-0.020 -0.51	0.390 9.91	+0.020 +0.51	10.562 268.28	-0.027 -0.69	0.094 2.39	0.134 3.40	10.92 277.4
12 300	12.750 323.9	+0.063 +1.60	-0.031 -0.79	0.719 18.26	-0.020 -0.51	0.390 9.91	+0.020 +0.51	12.531 318.29	-0.030 -0.76	0.109 2.77	0.156 3.96	12.92 328.2

"ES" ROLL GROOVE SPECIFICATIONS

COLUMN 1: Nominal IPS pipe size. Nominal metric (ISO) pipe size.

COLUMN 2: IPS outside diameter. Metric (ISO) outside diameter. The outside diameter of roll grooved pipe shall not vary more than the tolerance listed. For IPS pipe, the maximum allowable tolerance from square cut ends is 0.030" for ¾ - 3½" (20 - 90 mm); 0.045" for 4 - 6" (100 - 150 mm); and 0.060" for sizes 8" O.D. (200 mm) and above measured from true square line. For (ISO) metric pipe, the maximum allowable tolerance from square cut ends is 0.76 mm for sizes 20 mm - 80 mm; 1.14 mm for sizes 100 mm - 150 mm; and 1.52 mm for sizes 200 mm and above, measured from the true square line.

COLUMN 3: Gasket seat: the pipe surface shall be free from indentations, roll marks, and projections from the end of the pipe to the groove, to provide a leak-tight seal for the gasket. All loose paint, scale, dirt, chips, grease and rust must be removed. Square cut pipe must be used with FlushSeal® and EndSeal® gaskets. Gasket seat "A" is measured from the end of the pipe. **IMPORTANT:** Roll grooving may result in unacceptable pipe end flare. (See column 8.)

COLUMN 4: Groove width: bottom of groove to be free of loose dirt, chips, rust and scale that may interfere with proper coupling assembly. Corners at bottom of roll groove must have a radius of the following dimensions. For IPS pipe, 0.04R on 1½ - 12" (40 - 300 mm). For (ISO) metric pipe, 1.2R mm on 20 - 300 mm.

COLUMN 5: Groove outside diameter: the groove must be uniform depth for the entire pipe circumference. Groove must be maintained within the "C" diameter tolerance listed.

COLUMN 6: Groove depth: for reference only. Groove must conform to the groove diameter "C" listed.

COLUMN 7: Minimum allowable wall thickness: this is the minimum wall thickness which may be grooved.

COLUMN 8: Maximum allowable pipe end flare diameter. Measured at the most extreme pipe end diameter square cut or beveled.

ROLL GROOVE SPECIFICATIONS

DRAWN COPPER TUBING GROOVED WITH COPPER ROLLS

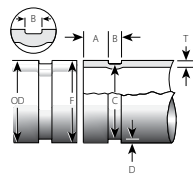

1	2		3	4	5	6	7	8
Nom. Size In. mm	Act. O.D. – Inches/mm		Dimensions – Inches/millimeters					
	Basic	Tolerance	Gasket Seat "A" ±0.03 ±0.76	Groove Width "B" +0.03/-0.00 +0.76/-0.00	Groove Dia. "C" +0.00 +0.00	Groove Depth (ref.) "D"	Min. Allow. Wall Thick. "T"	Max. Allow. Flare Dia.
2 50	2.125 54.0	±0.002 ±0.05	0.610 15.5	0.300 7.6	2.029 51.5	0.048 1.2	0.064 1.6	2.220 56.4
2½ 65	2.625 66.7	±0.002 ±0.05	0.610 15.5	0.300 7.6	2.525 64.1	0.050 1.2	0.065 1.7	2.720 69.1
3 80	3.125 79.4	±0.002 ±0.05	0.610 15.5	0.300 7.6	3.025 76.8	0.050 1.2	DWV	3.220 81.8
4 100	4.125 104.8	±0.002 ±0.05	0.610 15.5	0.300 7.6	4.019 102.1	0.053 1.4	DWV	4.220 107.2
5 125	5.125 130.2	±0.002 ±0.05	0.610 15.5	0.300 7.6	4.999 127.0	0.053 1.4	DWV	5.220 132.6
6 150	6.125 155.6	±0.002 ±0.05	0.610 15.5	0.300 7.6	5.999 152.3	0.063 1.6	DWV	6.220 158.0
8 200	8.125 206.4	* *	0.610 15.5	0.300 7.6	7.959 202.2	0.083 2.1	DWV	8.220 208.8

*Tolerances for 8" (200 mm) are + 0.002 (0.5 mm) –0.004 (–1.0 mm).

COLUMN 1: Nominal ASTM B-88 drawn copper tubing size as indicated in the chart heading.

COLUMN 2: Outside diameter: The outside diameter of roll grooved tubing shall not vary more than the tolerance listed. The maximum allowable tolerance from square cut ends is 0.030" (0.8 mm) for 2 - 3" (50 - 80 mm); 0.045" (1.1 mm) for 4 - 6" (100 - 150 mm), measured from true square line.

COLUMN 3: Gasket seat: The tubing surface shall be free from indentations, roll marks, and projections from the end of the tubing to the groove, to provide a leak-tight seat for the gasket. All loose scales, dirt, chips and grease must be removed.

COLUMN 4: Groove width: Bottom of groove to be free of loose dirt, chips and scale that may interfere with proper coupling assembly.

COLUMN 5: Groove outside diameter: The groove must be uniform depth for the entire tubing circumference. Groove must be maintained within the "C" diameter tolerance listed.

COLUMN 6: Groove depth: For reference only. Groove must conform to the groove diameter "C" listed.

COLUMN 7: ASTM B-306 drain waste and vent (DWV) is minimum wall thickness copper tubing which may be roll grooved.

COLUMN 8: Maximum allowable end flare diameter: Measured at the most extreme tubing end diameter.

VE416FS & VE416FSD

For complete contact information, visit www.victaulic.com

TM-VE416FS/FSD 0135 REV A UPDATED 05/1997

VICTAULIC IS A REGISTERED TRADEMARK OF VICTAULIC COMPANY. © 1997 VICTAULIC COMPANY.
ALL RIGHTS RESERVED. PRINTED IN THE USA.

